

**NEW ENGLAND'S CHOICE
AWNING SUPPLIES DISTRIBUTOR**



Awning & Marine Canvas Supplies Reference Book

Spring 2011

**Daily Deliveries
Throughout New England
and Nearby New York**



**Welcome to NEPCO's First Ever
Awning Supplies Catalog!**

NEPCO has been serving the sign and graphics industry since 1928. Our commitment to customer service has earned us more than a thousand returning customers in the Northeast and beyond.

It is in this spirit that we announce our entry into the Awning Supplies business. We will serve our new industry and customers with the same excellent service that has allowed our company to grow over the years.

Our truck delivery and low minimums are two things that distinguishes NEPCO from our competition. Low delivery minimums matched with our everyday low prices and in-stock availability is our recipe for success.

You should also note that we stock more than 10,000 different SKUs, in our warehouse... so if there's something you need... we probably have it. Just give us a call!

Consider trying NEPCO for your next supply order. You won't be disappointed.

~ Kirk Dexter, President.



NEPCO 800-327-7562
401-438-4550
fax 401-438-1533

Order Center Hours

Monday-Friday 7am-5pm

Warehouse/Counter Hours

Monday-Friday 8am-4pm

Our holidays can be found on our website.



Order Cut-Offs

Most UPS orders placed by 2pm will ship same day.

Delivery orders placed by 5pm will be delivered on the customer's next scheduled delivery day.

Payment Methods Accepted



Cash or Company Check
NEPCO Account
UPS COD

Our Office and Warehouse is located at:
125 Amaral Street
East Providence, RI 02915

Ordering/Shipping

When placing an order, please be certain to give your sales representative all pertinent information i.e. color, size, quantity and all item numbers (if known). Following this procedure will insure accurate processing of your order. We encourage the use of FAX or email.

Our delivery vehicles are standing by to provide accurate, timely delivery with any order received before 5:00PM THE DAY PRIOR TO YOUR SCHEDULED DELIVERY.

Please note that the minimum for delivery will vary based on your location. Call your sales rep for your minimum order. Unsuccessful deliveries may be subject to a \$5.00 re-delivery charge. UPS delivery (next day within Zone 2) will go out the day that the order is placed, as long as it is received prior to 2:00PM.

Returns and Defective Product

Please contact our returns department (Jeanette at x25) and a return authorization number will be assigned. All return claims must be made within 30 days of the invoice date. Defective items do not apply. Any unused items must be returned in its original packaging. We reserve the right to charge a fifteen (15%) percent restocking and handling fee on all returnable merchandise.

At no time, will NEPCO accept the return of lamps that are out of their case, even if they were purchased out of their case. NEPCO reserves the right to refuse the return of any item. (Our driver will test all bulbs for you on delivery)

NET Terms

Open accounts are available to qualified companies on credit approval. Open accounts carry net 30 terms with interest charges of one and one half (1.5%) percent per month levied against all delinquent accounts.

To open an account, please contact your sales representative. They will ensure that you are emailed a credit application package from our credit department. Please allow one to two weeks for approval notification. Until such time, all accounts will be on a pre-paid or COD (credit card or company check) basis.

Return of Checks Due to Insufficient Funds

Processing bounced checks is costly, so we will add \$30.00 automatically to your account for any and all checks that do not clear the bank.

Please call us if you have any questions!



Not Just Galvanized...
it's **GATORSHIELD**

by **allied**
TUBE & CONDUIT

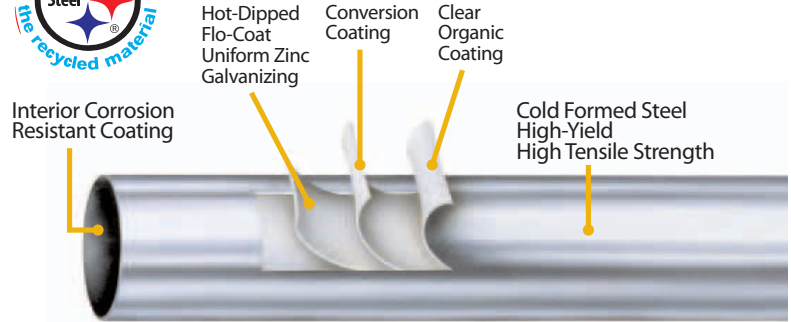

NEW

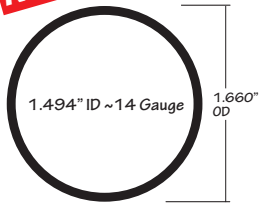

AWG-1660/24
1.494" ID x 14 gauge
24' Lengths

MOST POPULAR

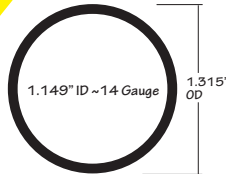

AWG-1315/24
1.149" ID x 14 gauge
24' Lengths

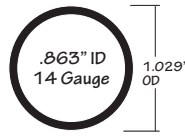

AWG-1029/24
.863" ID x 14 gauge
24' Lengths



AWG-815/24
.671" ID x 15 gauge
24' Lengths

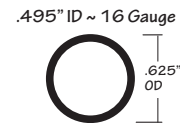

AWG-625/24
.495" ID x 16 gauge
24' Lengths



AWG-500/24
.402" ID x 18 gauge
24' Lengths

GatorStitch Steel Staple System

The strength of steel matched with the convenience of an aluminum staple-in channel!

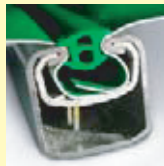

18GA/GATOSTITCH 1" x 1" 18 gauge.
20' Lengths Only

MOST POPULAR

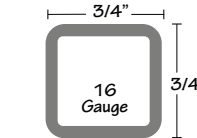

16GA/GAT.75X.75
3/4" x 3/4" x 16 gauge
24' Lengths

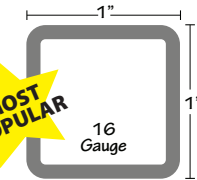

16GA/GATOR/24'
1" x 1" 16 gauge
24' Lengths

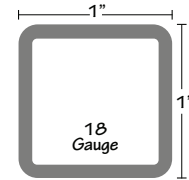

18GA/GATOR/24'
1" x 1" 18 gauge
24' Lengths

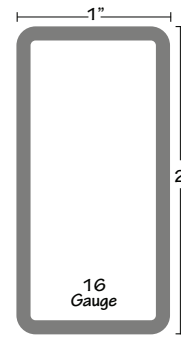

16GA/GATOR1x2
1" x 2" 16 gauge
20' Lengths

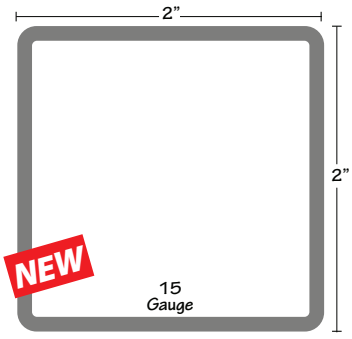

NEW

15GA/GATOR2x2
2" x 2" 15 gauge
24' Lengths

NEW

NEPCO TRIPLE COAT Smooth Galvanized Tubing

Small Order? No Problem!
Order what you need.
By the stick or by the bundle.

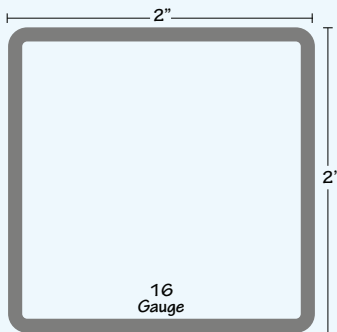

16GA/TRIPLE2X2
2" x 2" 16 gauge
24' Lengths

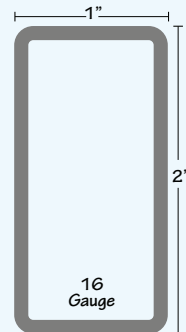

16GA/TRIPLE1X2
1" x 2" 16 gauge
24' Lengths

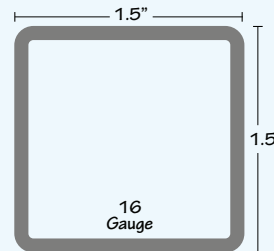

16GA/TPL1.5x1.5
1" x 2" 16 gauge
24' Lengths

1315/24/TRIPLE
1.149" ID x 14 gauge
24' Lengths

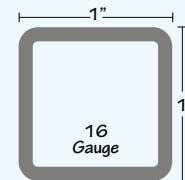
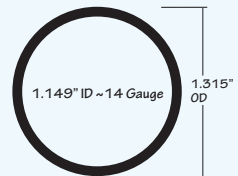

16GA/TRIPLE1X1
1" x 1" 16 gauge
24' Lengths

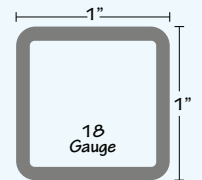

18GA/TRIPLE1X1
1" x 1" 18 gauge
24' Lengths

ALUMINUM AWNING TUBING

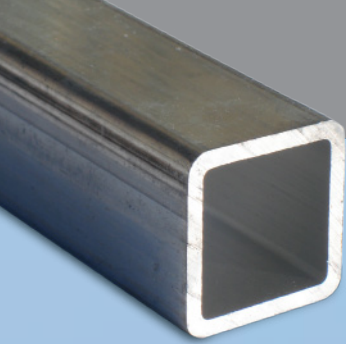

NEPCO Stocks More Awning Tubing for Next Day Truck Delivery!

Profiles shown are not to scale. See drawing for dimensions.

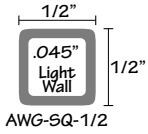

AWG-SQ-1/2 Light Wall
1/2" x 1/2"
.045" Wall
24' Lengths

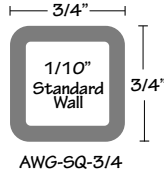

AWG-SQ-3/4 Standard Wall
3/4" x 3/4"
1/10" Wall
24' Lengths

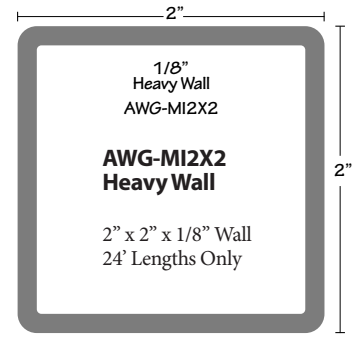

AWG-MI2X2 Heavy Wall
2" x 2" x 1/8" Wall
24' Lengths Only

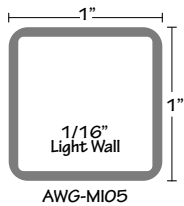

AWG-MI5 Light Wall
Steel Stitch #SMP-4D
1" x 1"
1/16" Wall
24' Lengths

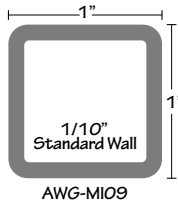

AWG-MI09 Standard Wall
Steel Stitch #SMP-4C
1" x 1"
1/10" Wall
24' Lengths

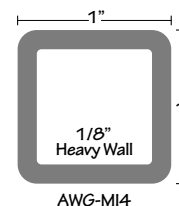

AWG-MI4 Heavy Wall
Steel Stitch #SMP-4B
1" x 1"
1/8" Wall
24' Lengths

MOST POPULAR

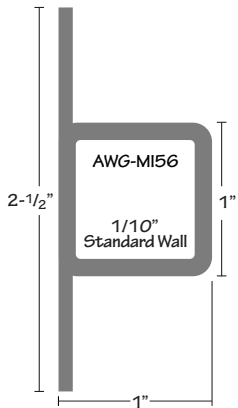

AWG-MI56 Standard Wall w/1" Flanges
Steel Stitch #SMP-3CP
1" x 1"
1/10" Wall
24' Lengths

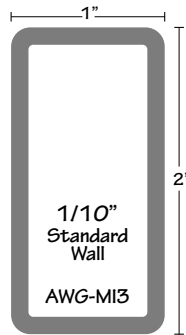

AWG-MI3 Standard Wall

1" x 2"
1/10" Wall
24' Lengths

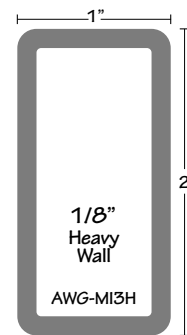

AWG-MI3H Heavy Wall

Steel Stitch #SMP-515
1" x 2"
1/8" Wall
24' Lengths

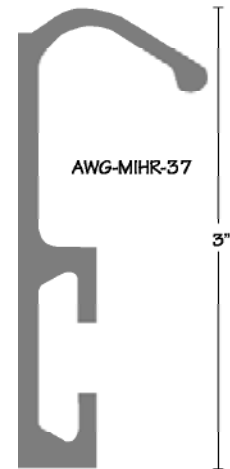

AWG-MIHR-37

AWG-MIHR-37 Head Rod
Molding Style #37
24' Lengths Only

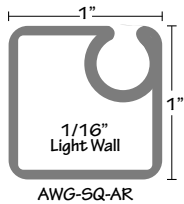

AWG-SQ-AR Light Wall w/Awning Rail
1" x 1" x 1/16" Wall
24' Lengths Only



AWG-MIAR Flat Awning Rail

1" x 20' Lengths

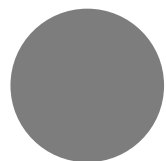

AWG-MIROD5 1/2" Round Solid Aluminum Rod
Steel Stitch #SMP-7
1" Round
20' Lengths Only

SAY GOODBYE TO COMMON CARRIERS!

Order a few lengths or a bundle. NEPCO delivers your awning materials with the lowest minimums in the Northeast!



NEPCO MATCHED STAPLE SYSTEM — ALUMINUM AWNING TUBING

MOST POPULAR

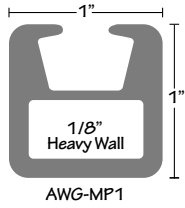

AWG-MP1 Heavy Wall
Steel Stitch #SMP-1B
1" x 1" x 1/8" Wall
24' Lengths Only

AWG-MP1

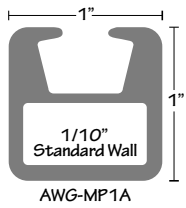

AWG-MP1A Standard Wall
Steel Stitch #SMP-1C
1" x 1" x 1/10" Wall
24' Lengths Only

AWG-MP1A

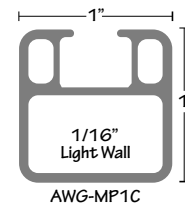

AWG-MP1C Light Wall
Steel Stitch #SMP-1D
1" x 1" x 1/16" Wall
24' Lengths Only

AWG-MP1C

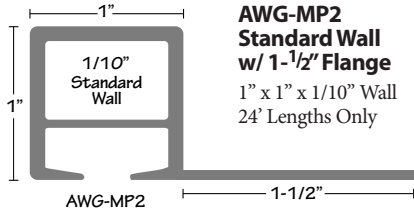

AWG-MP2 Standard Wall w/ 1-1/2" Flange
1" x 1" x 1/10" Wall
24' Lengths Only

AWG-MP2

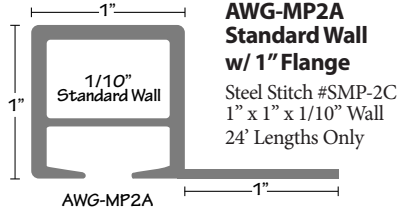

AWG-MP2A Standard Wall w/ 1" Flange
Steel Stitch #SMP-2C
1" x 1" x 1/10" Wall
24' Lengths Only

AWG-MP2A

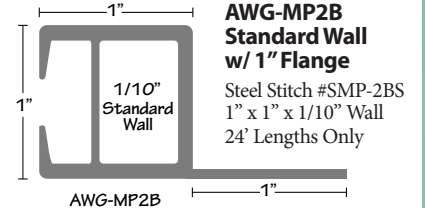

AWG-MP2B Standard Wall w/ 1" Flange
Steel Stitch #SMP-2BS
1" x 1" x 1/10" Wall
24' Lengths Only

AWG-MP2B

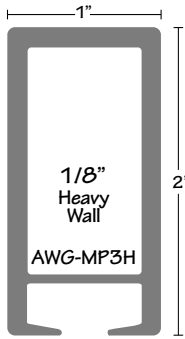

AWG-MP3H Heavy Wall
Steel Stitch #SMP-8B
1" x 2" x 1/8" Wall
24' Lengths Only

AWG-MP3H

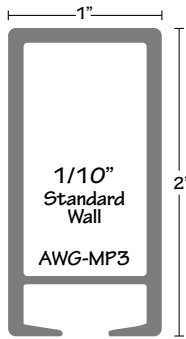

AWG-MP3 Standard Wall
Steel Stitch #SMP-8C
1" x 2" x 1/10" Wall
24' Lengths Only

AWG-MP3

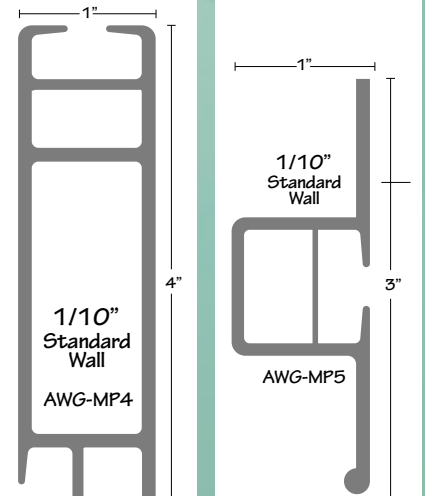

AWG-MP4

AWG-MP5

1" x 4" Beam
AWG-MP4 Standard Wall

1" x 4" x 1/10" Wall
24' Lengths Only

AWG-MP5 Standard Wall Facia Band Bleed Frame w/ 1" Flange

1" x 1" x 1/10" Wall
24' Lengths Only

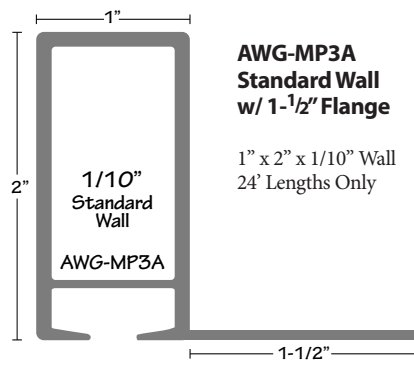

AWG-MP3A Standard Wall w/ 1-1/2" Flange
1" x 2" x 1/10" Wall
24' Lengths Only

AWG-MP3A

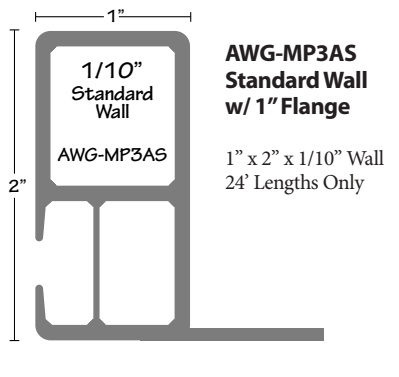

AWG-MP3AS Standard Wall w/ 1" Flange
1" x 2" x 1/10" Wall
24' Lengths Only

AWG-MP3AS

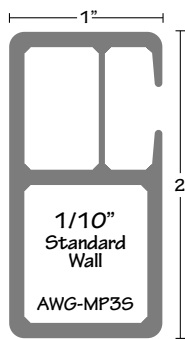

AWG-MP3S Standard Wall
1" x 2" x 1/10" Wall
24' Lengths Only

AWG-MP3S

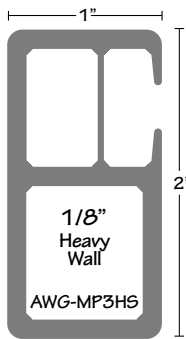

AWG-MP3HS Heavy Wall
1" x 2" x 1/8" Wall
24' Lengths Only

AWG-MP3HS

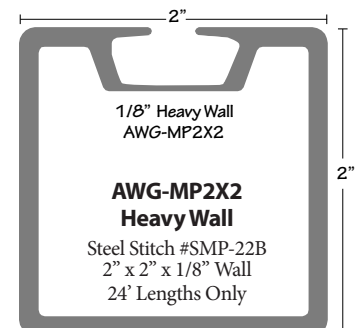

AWG-MP2X2

AWG-MP2X2 Heavy Wall
Steel Stitch #SMP-22B
2" x 2" x 1/8" Wall
24' Lengths Only



Introducing Recasens High Performance Fabrics

NEPCO is proud to be affiliated with Recasens USA. 100% Solution Dyed Acrylic Marine, Awning, Umbrella Fabrics, Waterproof Marine products, PVC coated fabrics, Outdoor Furniture and Shade Screen fabrics.

Recasens is the leading awning fabric in Europe!

S.A. Recasens is a fifth generation, family owned business founded in 1886. Recasens owns its own spinning, weaving, coating and finishing facilities, as well as offering full service R&D, design and testing services. Recasens USA has built its reputation as a powerful force in the textile industry by manufacturing high performance textiles, including the top rated Recacril® 100% solution dyed acrylic marine and awning canvas.

Recasens is the chosen supplier for many leading OEM manufacturers in the Marine and RV industries. Customers include Carefree of Colorado, manufacturer for the global OEM and Aftermarket RV market, and OEM boat companies Stingray, Cobalt, and Rinker power boats and Ameritex Fabric Systems to name a few.

Cut Yardage Available for All Fabrics
Call for Details



100% Solution Dyed Acrylic Marine & Awning Fabric

SUPER TIGHT WEAVE!

Zero shrink and Zero stretch with exceptional water and fade resistance in a full collection of 59 Solids and 79 Stripes.

Limited Five Year Warranty

Available 47", 60" & 98" Rolls

COLORS UPDATED IN 2009

With 59 Solids and 79 stripes in the Recacril® Line, Recasens is the company that delivers the styles and colors you want for your Commercial, Residential or Industrial customers and projects.



Proven in Europe, with over 50 years of experience, the Recacril® line is perfect for awnings, marine and other outdoor applications. With its tight weave, Recacril® provides outstanding water resistance and fabric stability.

NEPCO also offers **Recacril Binding (in 36 Colors & Five Styles)** and acrylic braiding to compliment any awning installation.



NEPCO Carries the ENTIRE Recasens Line!

View the complete Recasens catalog online at www.recusacatalog.com

Complete Fabric Swatch Books Available
Call for Details

TECHNICAL DATA

Base Fabric	100% Solution Dyed Acrylics	
Finish	Fluorocarbon/Resin	
Standard Put-Ups	65 yards/60 meters	
Finished Widths	47"/120cm	
	59"/150 cm	
Finish Weight/ Square Yard	9 oz.	
Limited Warranty	5 years	

Specifications	Test Method	Test Results
UV Resistance	AATCC-16	1500+ Hours
Abrasion	ASTM-4157	40,000 Rubs
Hydrostatic	AATCC-127	35 cm
Puncture Strength	ASTM-751	38 lbs
Tear Strength	ASTM-2261	9 lbs warp
		6 lbs fill
Tensile Strength	ASTM D-5034 Grab	255 lbs warp
		156 lbs fill
Shrinkage	Method 5804-100 hours	.4% warp
		0% fill
		0% warp
Stretch	ASTM D-2594	0% warp
		0% fill



NEPCO Delivers ALL of Your Awning Materials to Your Door.
Daily Deliveries Throughout New England and Nearby New York

Additional High Quality, High Performance Fabrics



RW-172 Blue (Shown)

Recwater Waterproof Acrylic

Recwater® is a waterproof product line that combines Recacril 100 percent solution-dyed acrylic with a PVC coating to create a material that resists weather, fading and shrinking. Recwater is available in 14 colors for automotive, marine, and other outdoor applications. Recwater comes in 60-inch width and 12 colors.

Roll Sizes: 47" x 65yd & 60" x 65 yd

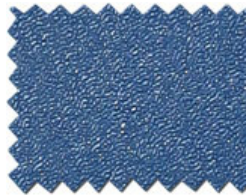

R-007 Blue (Shown)

NautiPlus & Nautimar Marine

Recasens' newest marine textiles, Nauti Plus® (12.7 ounces and PVC coated on two sides), and Nautimar® (8 ounces and coated on one side), are produced in 86-inch width.

Roll Size: 86" x 65 yds



R-7172 Wheat (Shown)

Decorline Furniture Fabric

Recacril Decorline® furniture fabric is an 8-ounce, furniture grade, 100 percent solution-dyed acrylic. Available in 20 solid colors and six patterns, this 54-inch fabric is used on marine or outdoor furniture cushions. Decorline is highly resistant to fading, tearing, stains and weather.

Roll Size: 54" x 65 yds



000 Blanco (Shown)

RecScreen Shade Screen

RecScreen® polyester shade screen filters UV rays and improves air circulation. RecScreen's **antibacterial, lead-free coating and fire-retardant characteristics** provide additional value to the environmentally conscious consumer. RecScreen's 118-inch width is unique in the industry, making it highly efficient during production and adaptable for a variety of applications in the shade screen product marketplace.

Roll Size: 118" x 32yds



158 Beige (Shown)

Solrec Polyester Awning

Solrec® a PVC/polyester for use in fabricating awnings, veranda covers, window shades and architectural shade systems, comes in 118-inch width and 32-yard lengths.

Roll Size: 118" x 32yds

Small order? No problem! NEPCO delivers with low-minimums and we don't use common carriers.

Cooley / Sign & Awning

The Benchmark for Eradicable Backlit Substrates

Cooley-Brite II® 10 Year Warranty

- 20 ounce, Eradicable, Flexible Sign and Awning Membrane
- This top-of-the-line membrane possesses all the advantages of our colored Cooley-Brite® and more. It features the added protection of our Coolthane® formulation, which enhances cleanability and extends the life of the product to 10 years.
- Available in 20 popular colors

Cooley-Brite® 8 Year Warranty

- 20 ounce, Eradicable, Flexible Sign and Awning Membrane, Cooley-Brite is a classic and enduring awning membrane used in end user applications worldwide.
- Nearly invisible to allow for maximum light diffusion, consistent translucency and brilliant colors in backlit signs and awnings. Treated with anti-wick, ultraviolet stabilizers, fungicides and whiteners for excellent color protection, durability and long life.
- Available in 16 bright colors

Cooley-Brite® Lite 8 Year Warranty

- 16 ounce, Eradicable, Colored, Flexible Membrane
- Translucent, flexible, durable, and features excellent lay-flat characteristics. Engineered for high color brilliance and consistent color translucency.
- Available in 20 bright colors

Roll Sizes:

6'-6" x 10 yd, 30 yd & 50 yd rolls

Custom seamed & cut yardage available.

ARLON SIGNTech®

Premium Backlit Vinyl Substrates

COLORKOTE™ TC 8 Year Warranty

Colorkote TC is a premium 21oz. eradicable, flexible, vinyl substrate coated with premium ink and covered with our advanced FX outer protective coating. **Available in 21 popular colors**, this pre-decorated flexible substrate is created for the sign and awning industries for backlit graphic applications with solid background coverage.

Designed to be eradicated using Signtech Eradicator.

Roll Sizes:

7' x 10 yd, 25 yd, 50yd rolls

Custom seamed & cut yardage available.

Custom Cut to Size Also Available

ERADICOLOR™ 10 Year Warranty

ERADICOLOR is an 18 oz. intermediate-grade, eradicable, flexible, vinyl substrate. **Available in 15 popular colors**, this value-priced flexible substrate can be used anywhere where a medium-term signage/awning solution is needed. Stretch your dollar with ERADICOLOR.

Designed to be eradicated using Signtech Eradicator.

Roll Sizes:

7' x 10 yd, 25 yd & 50 yd rolls

Custom seamed & cut yardage available.

Cooley Weatherlyte® Advanced Awning Fabrics

Weatherlyte is a 16oz technically advanced waterproof awning fabric, which offers the luxurious look and feel of a woven fabric but has all the benefits of a high performance composite vinyl. Weatherlyte can be decorated with conventional techniques and all colors can also be easily digitally printed.

Weatherlyte is the perfect fabric for applications where protection from the environment is key, such as boat covers and bimini tops, flags, awnings, banners and so much more.

Weatherlyte is UV and fungus resistant and is available in 20 standard colors.

- **8-Year Warranty**
- Looks and feels like a woven fabric without the weaknesses of one
- **Waterproof** Awning Fabric, not just water resistant
- **Flame Resistant**- meets CA Fire Marshall, ASTM E 84, NFPA 701
- Digitally printable
- Resists sagging better than a woven acrylic
- Resists stains and fungus
- Easy to clean
- 16 ounce weight
- 74" width means less seaming

NOW AVAILABLE

 Economical 11 oz.
 Advanced Awning Fabric
 Call for details!

- A** AWG-UAB-11
Zinc Short Leg Z-Bracket
- B** AWG-UAB-11L
Zinc Medium Leg Z-Bracket
- C** AWG-UAB-11L2
Zinc Long Leg Z-Bracket
- D** AWG-UAB-SEC
Zinc U-Bracket
- E** AWG-UWTL-11
Zinc Large Weld Tabs
- F** AWG-UWTS-11
Zinc Small Weld Tabs
- G** AWG-MI6
Aluminum Short Leg Z-Bracket

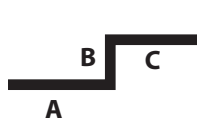
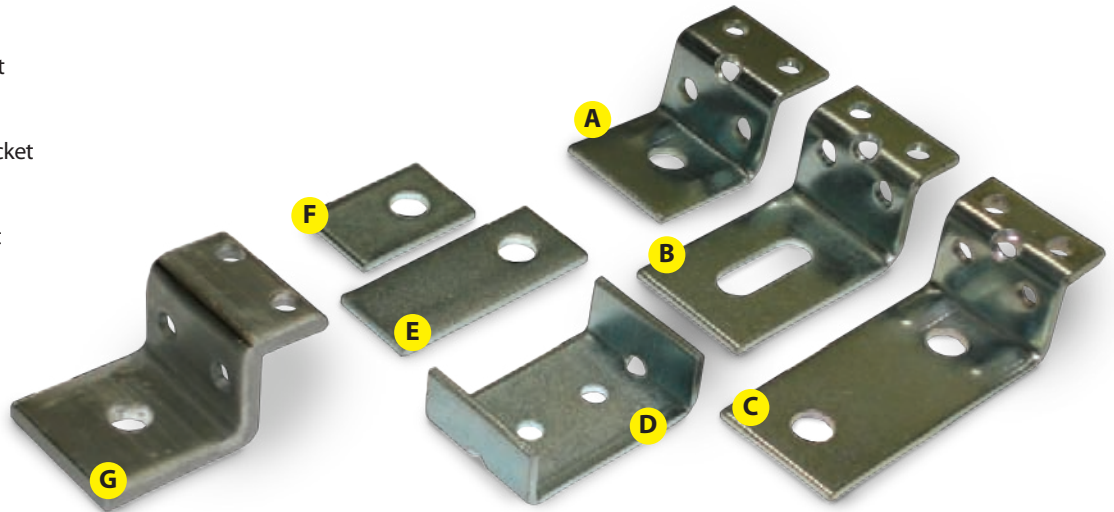

	A	B	C	Width	Length	Thickness
AWG-UAB-11	1.5"	1"	.87"	1.5"	--	1/8"
AWG-UAB-11L	2.46"	1"	.71"	1.5"	--	1/8"
AWG-UAB-11L2	3.25"	1"	.71"	1.5"	--	1/8"
AWG-UAB-SEC	--	--	--	1.5"	2.25"	1/8"
AWG-UWTL-11	--	--	--	.75"	2.5"	1/8"
AWG-UWTS-11	--	--	--	.75"	1.5"	1/8"



Aluminum Bracket System for Signs & Awnings

Build or Repair Awning and Sign Frames WITHOUT WELDING!

Build or Repair an Awning with TekScrews!
Keep a box on hand for unexpected field repairs.
Sold Individually
Call for a Price List!

AWG-1CLIP
FastClip #1



AWG-2CLIP
FastClip #2



AWG-3CLIP
FastClip #3



AWG-4LCLIP
FastClip #4L



AWG-4RCLIP
FastClip #4R



AWG-5LCLIP
FastClip #5L



AWG-5RCLIP
FastClip #5R



AWG-6CLIP
FastClip #6



AWG-7CLIP
FastClip #7



AWG-8CLIP
FastClip #7



AWG-9CLIP
FastClip #9



ColorPlus Zip Strip / Vinyl Inserts



























~ Low-Profile Staple Channel Covers.

~ Maximum UV Inhibitors and Mildew Resisters for Long Life.

~ Supple Durometer Means Less Labor

~ Tight Fit Design (air chamber expands and contracts)

	Black	AWG-CP01		Pink	AWG-CP10		Plum	AWG-CP19
	Dark Blue	AWG-CP02		Red	AWG-CP11		Sunflower	AWG-CP20
	Mid Blue	AWG-CP03		Clear	AWG-CP12		Beige	AWG-CP21
	Brown	AWG-CP04		Teal	AWG-CP13		Light Green	AWG-CP22
	Burgundy	AWG-CP05		Terracotta	AWG-CP14		Light Blue	AWG-CP23
	Green	AWG-CP06		Turquoise	AWG-CP15		Navy Blue	AWG-CP24
	Gray	AWG-CP07		White	AWG-CP16		Taco Bell	AWG-CP29
	Ivory	AWG-CP08		Yellow	AWG-CP17			
	Orange	AWG-CP09		Magenta	AWG-CP18			

Available in 350' Rolls Only

CALL FOR PRICING!

Specialized Awning Assembly Tools



Vice Grip Tensioning Clamp

The perfect tool for tensioning fabrics in staple system awning assembly. Keep several on hand.

AWG-MI16A
Sold individually

Standard Tubing Bender (shown)

Less expensive solution for bending aluminum extrusions or steel tubing quickly and efficiently

Bends 1/2", 3/4" and 1" square tubing.
Bends 3/4" and 1" round tubing.

Deluxe Tubing Bender (not shown)

Bends various sizes without changing wheels.
Also bends up to 2" tubing!

Bends 1/2", 3/4", 1" & 2" square tubing.
Bends 1" x 2" rectangular tubing in both directions.
Bends 3/4", 1", 1-1/4", 1-1/2" and 2" round tubing.



Detailed specs and pricing available on request.



Air Hammer

Makes inserting zip strips a breeze!
Provides the perfect amount of cushioned force.

AWG-MI12
Sold individually



Air Staple Gun

This specialized air staple gun was designed specifically to work with staple system awning assembly. Perfect pressure to pierce the aluminum cleanly and hold the fabric securely without tearing.

AWG-MI11A
Sold individually

Stainless Steel Staples

Premium staples that resist corrosion. Perfect for awnings near the water or marine installations.

AWG-MI95S
5,000/Box

Galvanized Steel Staples

Great general purpose staples for use in any staple system assembly. Made especially for awning fabrication.

AWG-MI9G
5,000/Box

Standard High-Output, Low-Profile Fluorescent Light Fixtures

Available in 4', 6' & 8' Lengths
One Price / Any Size!

4' Fixture 4-L248HO-DL
6' Fixture 6-L272HO-DL
8' Fixture 8-L296HO-DL

Call for the lowest price!

UL Listed for Damp and Dry Locations

Two Lamp Type with Energy-Efficient Low Profile Electronic Ballast

Pre-finished 23 Gauge Steel with White Baked-on Enamel

Can be used in a Continuous Run or as a Single

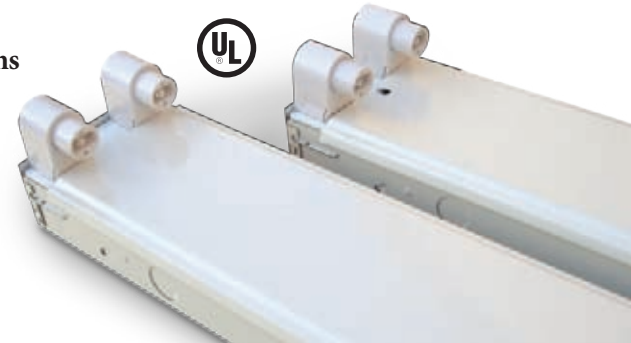

T12 High-Output Fluorescent Lamps



NEPCO STOCKS ALL SIZES— From 18" to 120".
Cool White and Daylight.

BUY SINGLES OR BUY THE CASE!

	Daylight	Cool White
4'	F48T12/D/HO	F48T12/CW/HO
6'	F72T12/D/HO	F72T12/CW/HO
8'	F96T12/D/HO/CT	F96T12/CW/HO/CT

NO ONE BEATS NEPCO ON LIGHTING!

Our Roots Are In Lighting.
We stock more lamps and offer the BEST PRICES and WIDEST SELECTION in the industry.

NO MORE BROKEN LAMPS!

Order a few lamps or a few cases! NEPCO safely delivers your lighting supplies with the lowest minimums in the Northeast!



2' x 4' White Styrene
1/2" x 1/2" x 3/8" Grid

2x4EGG (25/Carton)

Styrene Egg Crate Awning Lens

White egg crate panels are the most popular material in the awning industry for overhead back-lit awnings. Egg crate panels conceal light fixtures and wiring while allowing substantial light to shine down.

Manufactured of durable styrene, they can easily be cut to size with standard cutting tools.



NEPCO is long known to be the Premiere Wholesale Neon Fabricating Facility in the Northeast. We're also one of the largest wholesale suppliers of ballasts, transformers, and all types electrical supplies for the sign, graphics and awning industry.

ONE CALL FOR ALL OF YOUR SIGN, GRAPHICS & AWNING SUPPLIES!

NEPCO Sales Team

Customer Service Hours: 7am-5pm

For the Very Best Service,
Please Contact Your Assigned
Sales Representative or
Dial 5 for the Next Available Salesperson



Jeff Charbonneau
Outside Sales
Northeast Region
14 Years
800-327-7562 x16
401-742-4096 Cell
j.charbonneau@nepcosignsupply.com



Kirk Dexter
President
32 Years
800-327-7562
k.dexter@nepcosignsupply.com



Lynn Diminico
Inside Sales
Marketing
15 Years
800-327-7562 x22
l.diminico@nepcosignsupply.com



Eric Gibree
Inside Sales
Sign & Awning Specialist
3 Years
800-327-7562 x15
e.gibree@nepcosignsupply.com



Gary Martins
Inside Sales
Sign & Awning Specialist
9 Years
800-327-7562 x21
g.martins@nepcosignsupply.com



Gene Medeiros
Purchasing
& Inside Sales
Sign & Awning Specialist
14 Years
800-327-7562 x31
g.medeiros@nepcosignsupply.com



Richard Sutton
General Manager
22 Years
800-327-7562 x13
r.sutton@nepcosignsupply.com



Ernie Viveiros
Technology Sales
Roland Service/Support
2 Years
800-327-7562 x19
508-828-8032 Cell
e.viveiros@nepcosignsupply.com

The Best Support Staff in the Industry!



Sarah Ancil
Purchasing
4 Years
Ext. 12
s.ancil@nepcosignsupply.com



Sherrie Capuano
Credit Manager
18 Years
Ext. 18
s.capuano@nepcosignsupply.com



Tony Corveno
Order Processing &
Delivery Planning
20 Years
Ext. 24
t.corveno@nepcosignsupply.com



Susan Dexter
Office Manager
14 Years
Ext. 26
s.dexter@nepcosignsupply.com



Jeanette Fernandes
Product
Returns
9 Years
Ext. 25
j.fernandes@nepcosignsupply.com



Diane Huftalen
Accounts
Receivable
12 Years
Ext. 11
d.huftalen@nepcosignsupply.com



Sue O'Sullivan
Accounts
Payable
3 Years
Ext. 17
s.osullivan@nepcosignsupply.com



Leo Correia
Purchasing
Ext. 32
l.correia@nepcosignsupply.com



Joe Bento
Warehouse
& Neon
8 Years



David Keane
Warehouse
Supervisor
2 Years



Bobby Loccisano
Deliveries
2 Years



Jim Munroe
Neon
Manufacturing
Specialist
17 Years



Gator
Vehicle
Maintenance &
Deliveries
11 Years



Dick Southiere
Deliveries
12 Years



Rick Webb
Rock Star &
Deliveries
8 Years



New England Warehouse & Company Headquarters
125 Amaral Street, East Providence, RI 02915
Warehouse Pickup Hours: 8am-4pm

800-327-7562 | sales fax 401-438-1533